

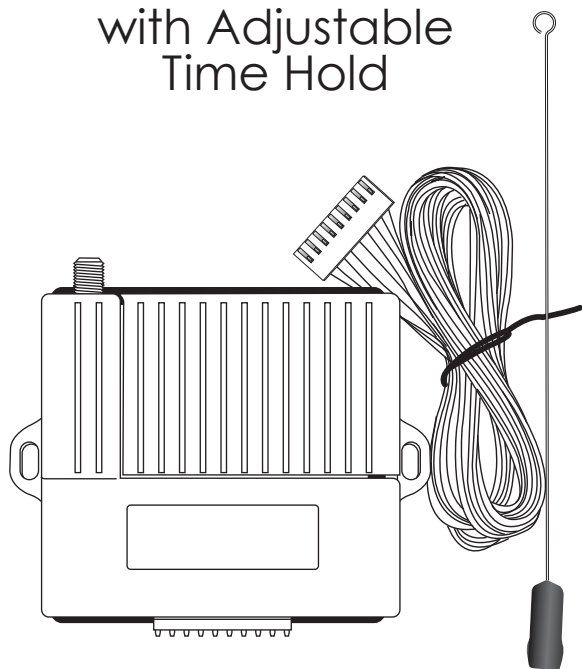

300/310 Hive Receiver Instructions

with Adjustable
Time Hold



Congratulations on purchasing the most state-of-the-art and simple to use receiver currently available on the market. The receiver has been designed for ease of use and longevity in the field. Follow these simple instructions and you will have your new receiver installed and running in a very short time.

Step 1. Open the access door by sliding it to the right. See Fig. 1.

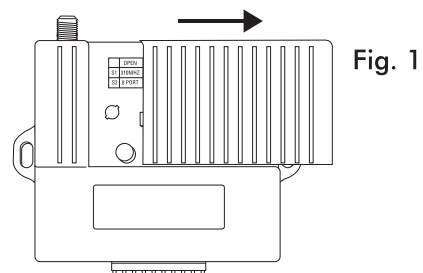

Step 2. You can now see the jumper and dip switches. See Fig. 2

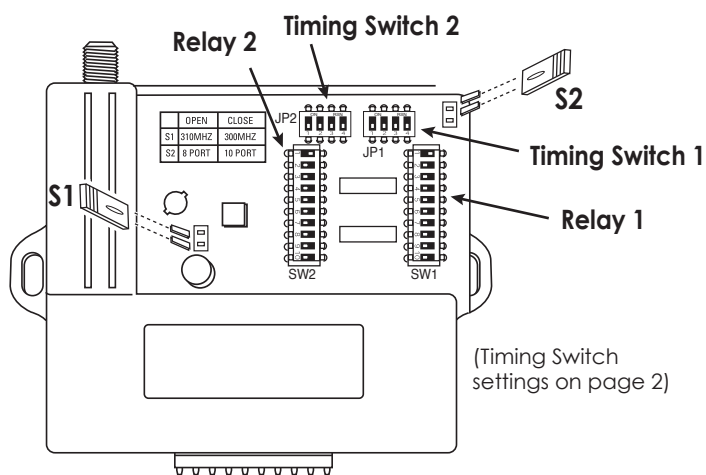

Fig. 2

(Timing Switch settings on page 2)

Step 3. The Hive Receiver will automatically detect voltages between 12 - 24 V, either AC or DC.

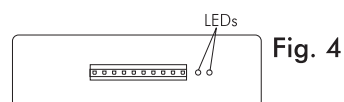
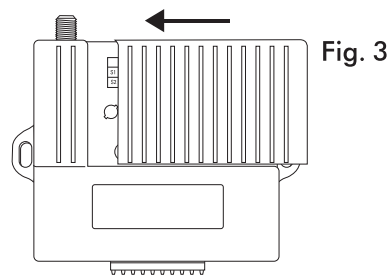

Fig. 3

Fig. 4

Step 4. Determine the operating frequency you will use on your installation. The Transmitter Solutions Hive receiver can operate at either 300 MHz or 310 MHz. At 300 MHz the hive receiver is compatible with all MultiCode transmitters with 10 dip switches operating at 300 MHz. At 310 MHz the Hive receiver is compatible with all Linear transmitters with 8 dip switches and Stanley transmitters with 10 dip switches operating at 310 MHz. See Fig. 2.

- A. For 300 MHz with 10 dip switches, jumpers S1 and S2 must be in place.
- B. For 310 MHz with 8 dip switches, jumpers S1 and S2 must be removed.
- C. For Stanley 310 MHz with 10 dip switches, jumper S1 must be removed, and jumper S2 must be in place.

Step 5. Set the dip switches to the desired settings to match your transmitters SW1 controls Relay 1 and SW2 controls Relay 2. Refer to Fig. 2.

Step 6. Wire the receiver harness according to the wiring diagram, (See Fig. 5). For ease of installation the wires are color coded. For most standard gate and door installations you will wire the open input of your gate operator or garage door, with the common and NO (normally open) contact of either relay 1, 2 or both. See Fig. 5.

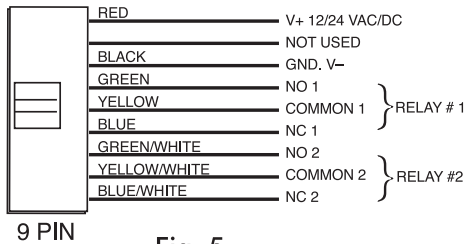

Fig. 5

Step 7. Attach the wiring harness to the receiver. See Fig. 6.

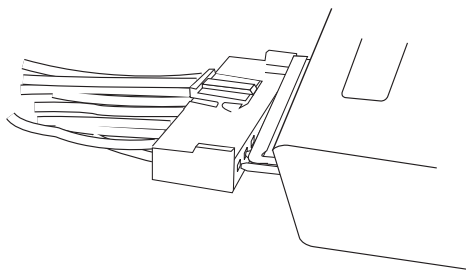

Fig. 6

Step 8. Verify the receiver has power. This can be verified by observing if LED1 and LED2 are illuminated. See Fig. 4.

Step 9. Push a transmitter that is programmed to the same code as the receiver. If you hear the relay click and see the LED flash quickly, you have successfully wired the receiver.

Step 10. Close the access door on the receiver. See Fig 3.

Step 11. Mount the receiver in a safe and convenient location on your installation. Remember to take care to avoid items that may cause interference with the receiver such as electric motors, etc. The receiver can be attached with either the mounting screw holes of the housing or by using industrial strength Velcro.

Step 12. Install the coax antenna (provided) by screwing it onto the antenna mount which protrudes from the housing.

Step 13. After you have completed the installation check for operational range from various areas around the installation. If the range is less than desired, try re-positioning the antenna, receiver, or both and re-test the range.

JP1 and JP2 Relay time setting:

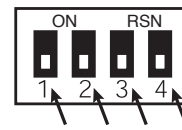

- Relay time output 1 second
- Relay time output 5 seconds
- Relay time output 10 seconds
- Relay time output 15 seconds
- Relay time output 20 seconds
- Relay time output 15 seconds
- Relay time output 25 seconds
- Relay time output 30 seconds
- Relay time output 50 seconds

Congratulations on successfully installing your Hive receiver! If you have any questions, please do not hesitate to call us.



7380 S Eastern Ave. #124-320 • Las Vegas, NV 89123
 (866) 975-0101 • (866) 975-0404 fax
 sales@transmittersolutions.com

Multicode, Linear and Stanley are registered trademarks owned by Linear Corporation..