

FLAT

LED GARDEN LIGHTS



PLUS

Step lights, or for garage doors and pergolas

Completely made of aluminium

DIMENSIONS

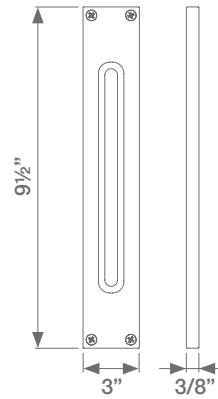

24-35Vdc

CRI>70

4400K

132lm

IP54

2W

PHOTOMETRIC

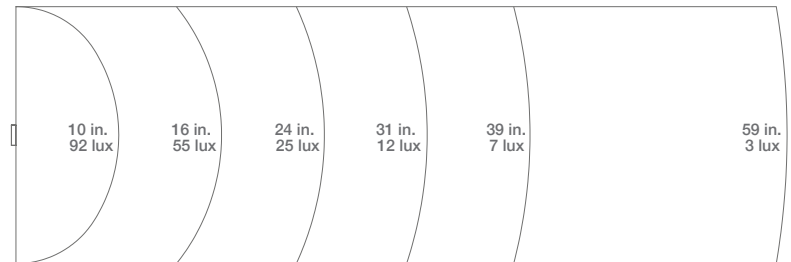
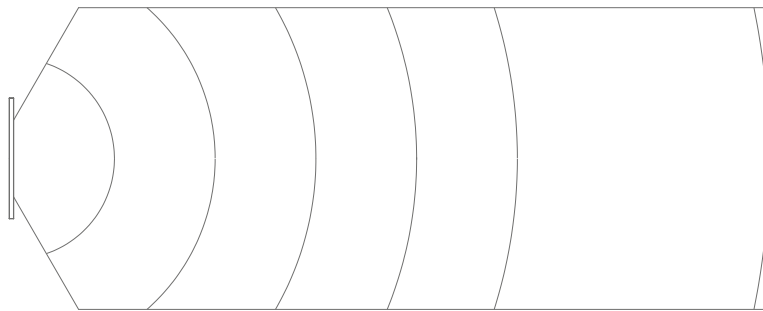

available colours:



WHITE



BROWN



GREY

MODELS

DESCRIPTION	WEIGHT
Pair of led garden lights, color WHITE. H= 9½ inches	! 2PCS 3.75 lbs
Pair of led garden lights, color BROWN. H= 9½ inches	! 2PCS 3.75 lbs
Pair of led garden lights, color GREY. H= 9½ inches	! 2PCS 3.75 lbs

STELLA

LED GARDEN LIGHTS



PLUS

Led lights to light up large areas

Completely made of aluminium, H= 23 5/8" or 38 13/16"

Replaceable led

LIGHT BEAM CONFIGURABLE AT WILL

STANDARD

24-35Vdc

CRI>70

4400K

264lm

IP54

8W

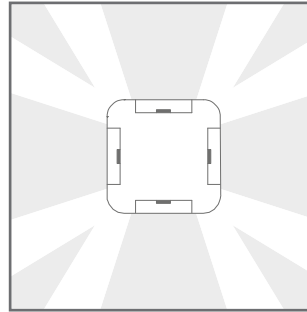

ANGULAR

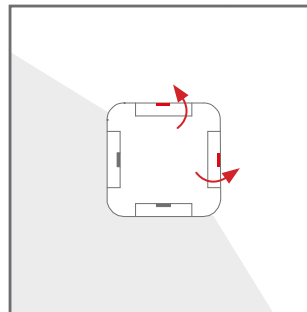

LINEAR

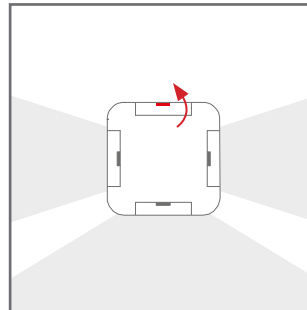

MODELS

DESCRIPTION

Led garden lights, color GREY. H= 23 5/8"

Led garden lights, color GREY. H= 38 13/16"

WEIGHT



8.1 lbs



11.2 lbs

STIK M

LED GARDEN LIGHTS



PLUS

Garden lights with height 29 1/2" with front light

Completely made of aluminium

Replaceable led

DIMENSIONS

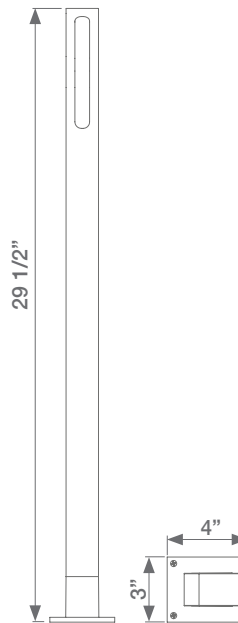

24-35Vdc

CRI>70

4400K

132lm

IP54

2W

PHOTOMETRIC

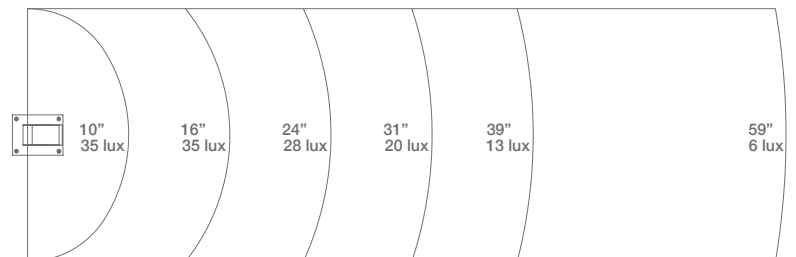
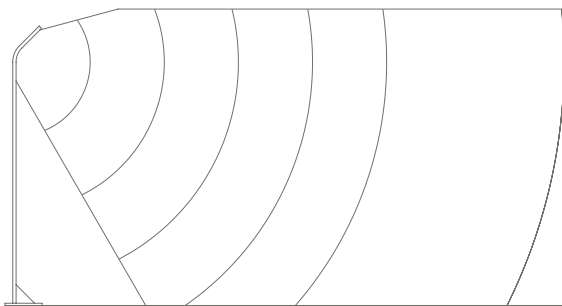

available colours:



WHITE



BROWN



GREY

MODELS

DESCRIPTION

WEIGHT

Pair of led garden lights, color WHITE. H= 29 1/2"

! 2PCS

4.4 lbs

Pair of led garden lights, color BROWN. H= 29 1/2"

! 2PCS

4.4 lbs

Pair of led garden lights, color GREY. H= 29 1/2"

! 2PCS

4.4 lbs

STIK S DOWN

LED GARDEN LIGHTS



PLUS

Garden lights with height 16" with front light

Completely made of aluminium

Replaceable led

DIMENSIONS

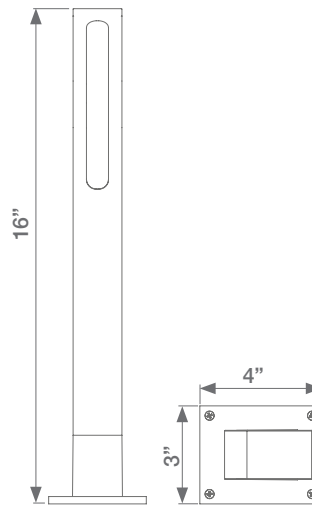

24-35Vdc

CRI>70

4400K

132lm

IP54

2W

PHOTOMETRIC STIK S DOWN

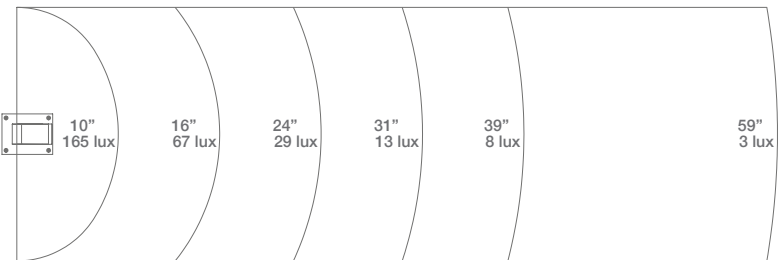
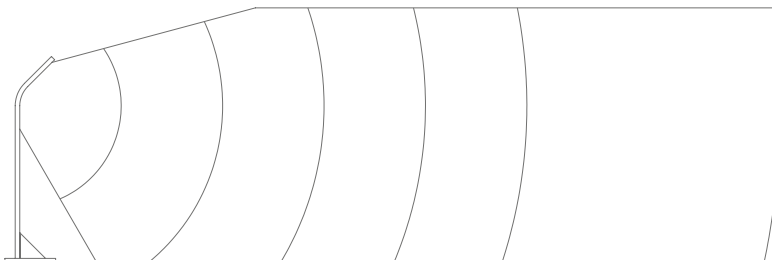

available colours:



WHITE



BROWN



GREY

MODELS

DESCRIPTION

WEIGHT

Pair of led garden lights, version DOWN, color WHITE. H= 16"



3.75 lbs.

Pair of led garden lights, version DOWN, color BROWN. H= 16"



3.75 lbs.

Pair of led garden lights, version DOWN, color GREY. H= 16"



3.75 lbs.

STIK S UP

LED GARDEN LIGHTS



PLUS

Garden lights with height 16" with back light

Completely made of aluminium

Replaceable led

DIMENSIONS

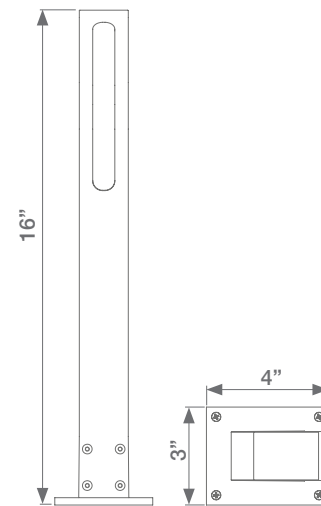

24-35Vdc

CRI>70

4400K

132lm

IP54

2W

PHOTOMETRIC STIK S UP

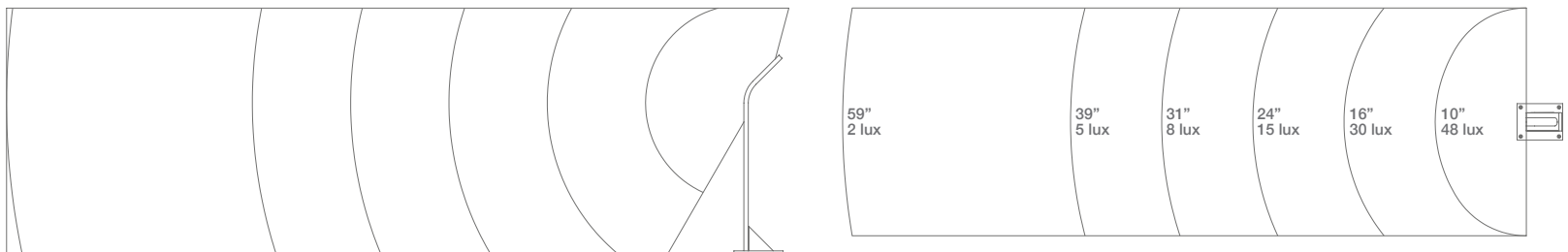

available colours:



WHITE



BROWN



GREY

MODELS

CODE	DESCRIPTION	WEIGHT
	Pair of led garden lights, version UP, color WHITE. H= 16"	! 2PCS 3.75 lbs.
	Pair of led garden lights, version UP, color BROWN. H= 16"	! 2PCS 3.75 lbs.
	Pair of led garden lights, version UP, color GREY. H= 16"	! 2PCS 3.75 lbs.

TOWER

LED GARDEN LIGHTS



PLUS

Lights with double led strip, suitable for parking lots and public areas

Completely made of aluminium

Replaceable led

DIMENSIONS

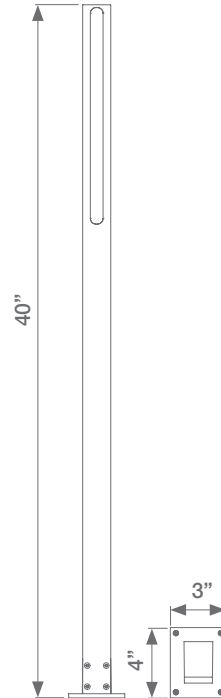

24-35Vdc

CRI>70

4400K

264lm

IP54

4W

PHOTOMETRIC

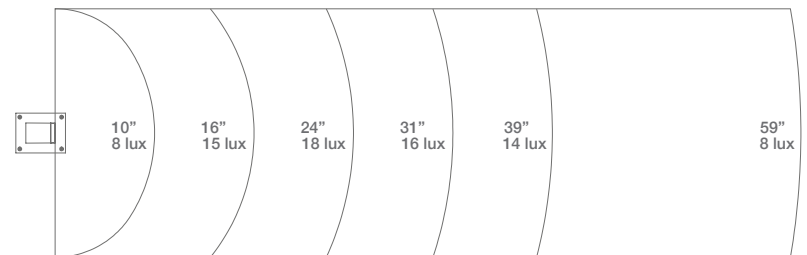
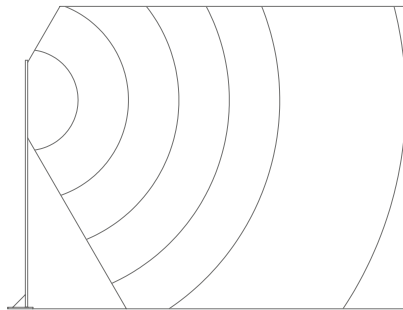

available colours:



WHITE



BROWN



GREY

MODELS

DESCRIPTION

WEIGHT

Pair of led garden lights, color WHITE. H= 40"

! 2PCS 6 lbs.

Pair of led garden lights, color BROWN. H= 40"

! 2PCS 6 lbs.

Pair of led garden lights, color GREY. H= 40"

! 2PCS 6 lbs.

VERTICAL

LED GARDEN LIGHTS

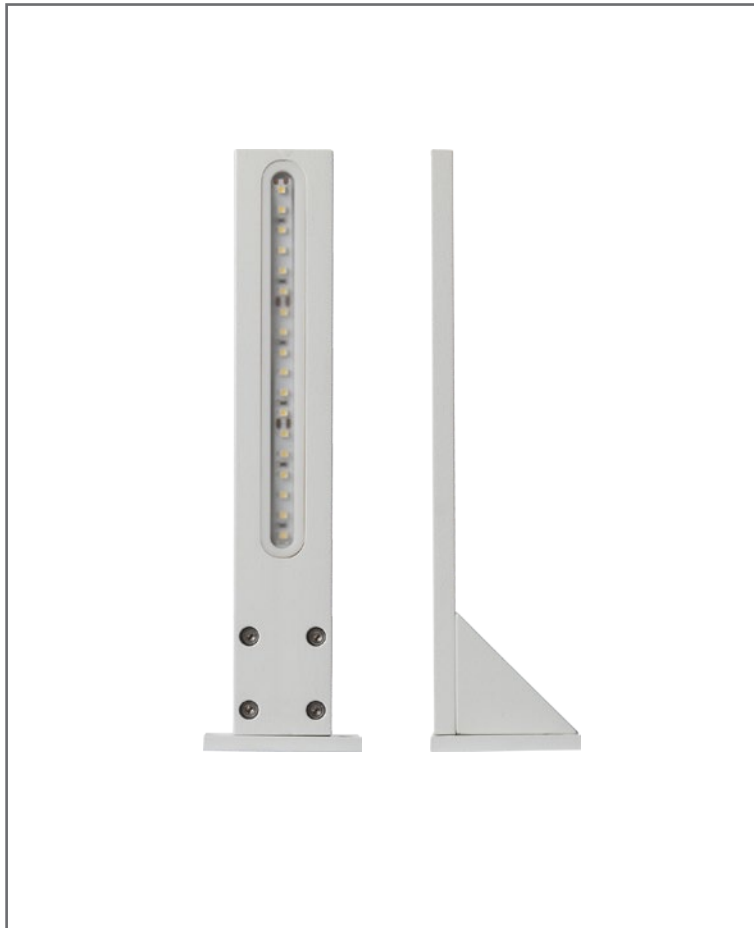

PLUS

Lights for pedestrian or vehicular premises, to be installed on top of the fence

Completely made of aluminium

Replaceable led

DIMENSIONS

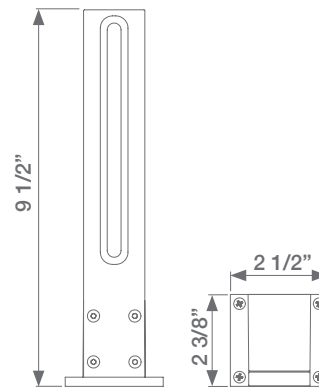

24-35Vdc

CRI>70

4400K

132lm

IP54

2W

PHOTOMETRIC

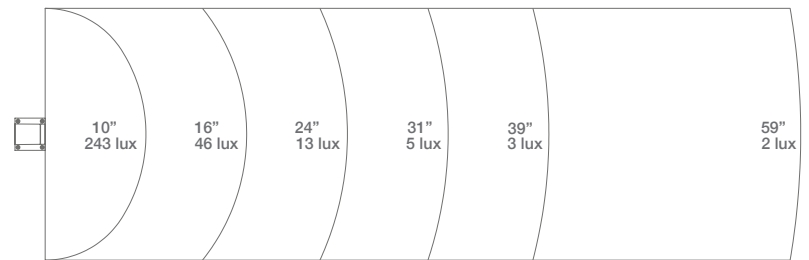
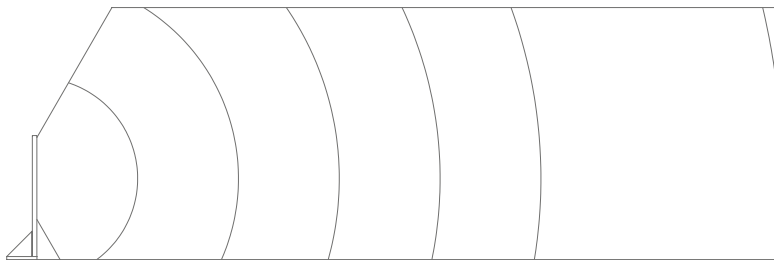

available colours:



WHITE



BROWN



GREY

MODELS

DESCRIPTION

Pair of led garden lights, color WHITE. H= 9 1/2"

Pair of led garden lights, color BROWN. H= 9 1/2"

Pair of led garden lights, color GREY. H= 9 1/2"

WEIGHT



2PCS

3.75 lbs.



2PCS

3.75 lbs.



2PCS

3.75 lbs.